



# suprema Xpass

## Smart IP Access Reader

TCP/IP Ready  
Wiegand/RS485 Interfaces  
IP65 Waterproof  
Power over Ethernet

## Contents

<b>Safety Precautions</b>	3
<b>Product Components</b>	5
<b>Optional Accessories</b>	6
<b>Product Description</b>	7
<b>Product Dimension</b>	10
<b>Cables and Connectors</b>	11
<b>Power Connection</b>	14
<b>LAN Connection</b>	16
<b>RS485 Connection</b>	18
<b>Relay Connection</b>	20
<b>Digital Input Connection</b>	23
<b>Wiegand Input/Output</b>	25
<b>External Power Output</b>	26
<b>Installation of Wall-mount Bracket</b>	27
<b>Installation Reference</b>	28
<b>Specification</b>	31
<b>Electrical Specification</b>	32
<b>FCC Rules</b>	33

## Safety Precautions

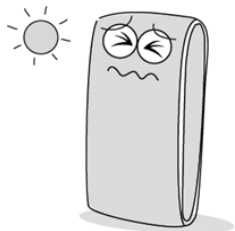

Do not install the device in a place subject to direct sun light, humidity, dust or soot.

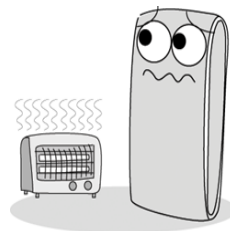

Do not place the device next to heating equipments.



Do not place a magnet near the product.

▶ It may cause a damage or a failure to the product.

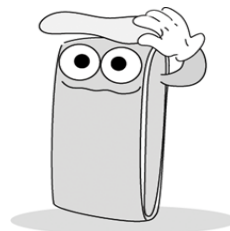

When cleaning, do not splash water on the device but wipe it out with a smooth cloth or towel.

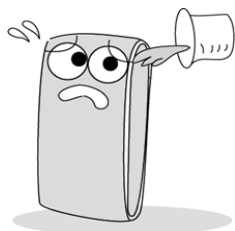

Be careful not to let liquids like water, drinks or chemicals leak inside the device.

▶ It may cause a failure.

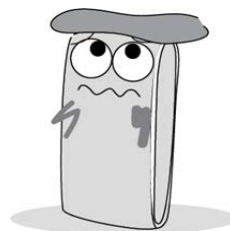

Clean the device often to remove dust on it.

**The list below is to keep user's safety and prevent any loss. Please read safety precautions carefully before use.**

## Safety Precautions



Do not drop the device.



Do not disassemble, repair or alter the device.

▶ The warranty does not apply to any product damage caused by an arbitrary installation or repair.



Do not let children touch the device without supervision.



Do not use the device for any other purpose than specified.

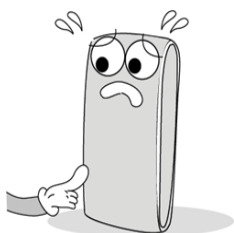

Do not damage the device.



Contact your nearest dealer in case of a trouble or problem.

**The list above is to keep user's safety and prevent any loss. Please read safety precautions carefully before use.**

## Product Components

### Basic Components



Xpass

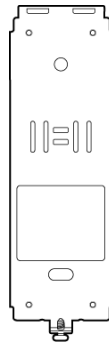

Bracket



Extended Ethernet Cable



Wall Mounting Screws  
(2 ea)



Knife Blocks  
(2 ea)



Shrinkable Tubes



Diode  
(1 EA)

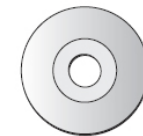

Software CD

 The components shown above may differ depending on the installation environment.

## Optional Accessories



Secure I/O

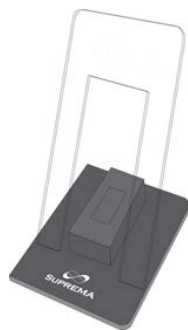

Plastic stand

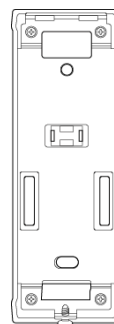

Extended Bracket

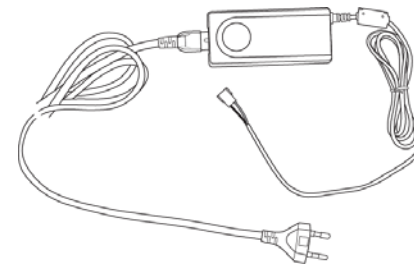

Adaptor

## Product Description

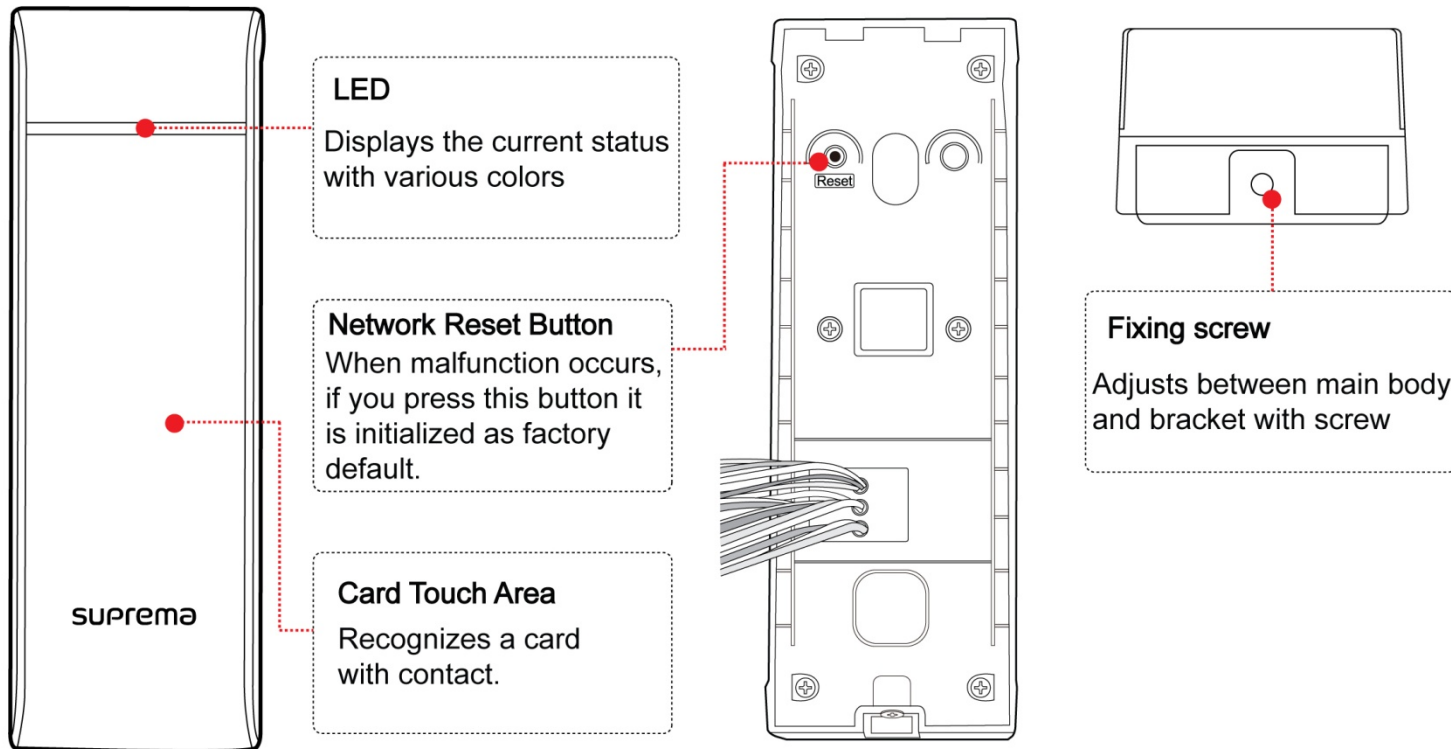

LED status

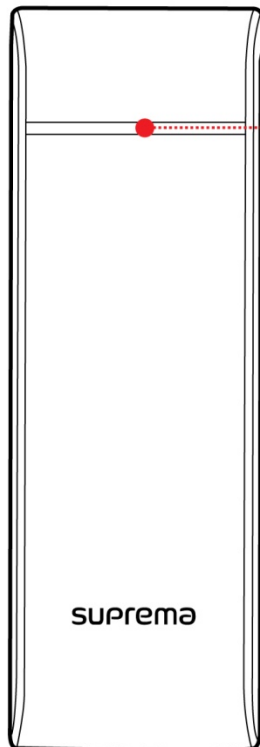

LED Status per Color		
Color	Sound	Description
Green	Beep Beep Beep	Authorization Success
Red	Be~ep	Authorization Fail
Pink	Beep!	On Processing
Flicker Blue/Sky-Blue Color per 2sec	No sound	Normal
Flicker Red/Pink Color per 2sec	No sound	Locked
Flicker Blue/Red Color per 2se	No sound	Initialized Time due to the Internal Battery Discharge
Flicker Blue /Yellow Color per 2sec	No sound	IP address is not assigned when terminal is set as 'Use' in the 'DHCP' of 'TCP/IP Setting'
For first operation, red LED is blinking by every 2 seconds.	No sound	Failed. Please contact to your distributor or Suprema
For normal operation, red LED is blinking by every 2 seconds.	No sound	Security status
Yellow LED is blinking shortly.	No sound	Terminal is send or received a packet to get IP address when terminal is set as 'Use' in the Idle status or 'TCP/IP Setting'



## ● Initialization of network setting

When you install the Xpass or forget the network setting's value of Xpass in use, can initial the network setting's value (TCP/IP address, RS-485 setting) in the switch of Xpass's back side as follows;

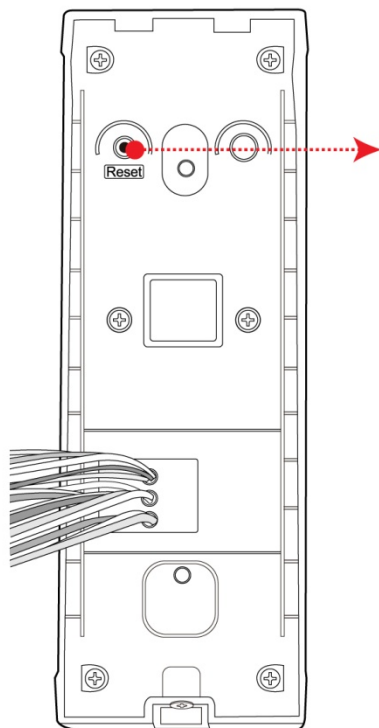

### Initializing the network setting

1. Press the Reset button in the switch of Xpass's back side for 3 second or above.
2. Connect between Xpass and Biostar Client(Ver.1.25 or higher) by using TCP/IP or RS-485.
  - Network default setting value
  - TCP/IP Address(Fixed): 192.168.0.1. Not Checked: Use Server
  - RS-485 : PC Connection, 115200 bps
3. Enter th desired value of TCP/IP address or RS-485 to change setting value. And save setting value.
4. After delete the Xpass among devices list, re-connect bewteen Xpass and BioStar using the new TCP/IP address or RS-485 setting.

## Product Dimension

(unit : mm)

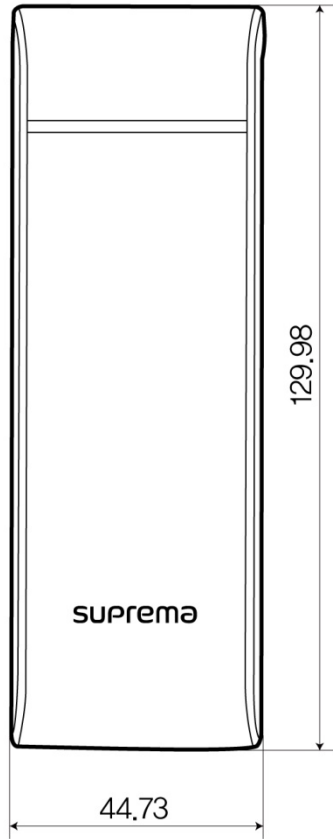

< Front View >

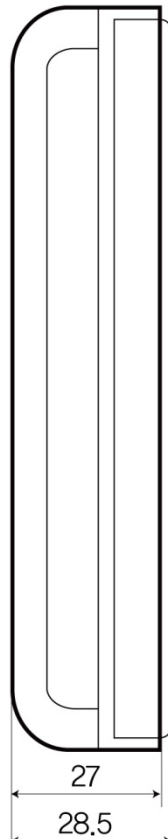

< Side View >

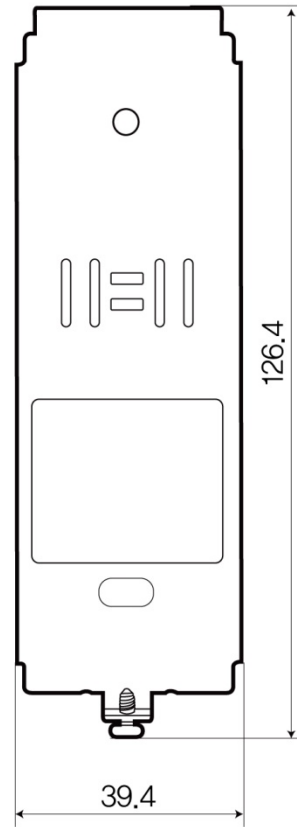

< Bracket >

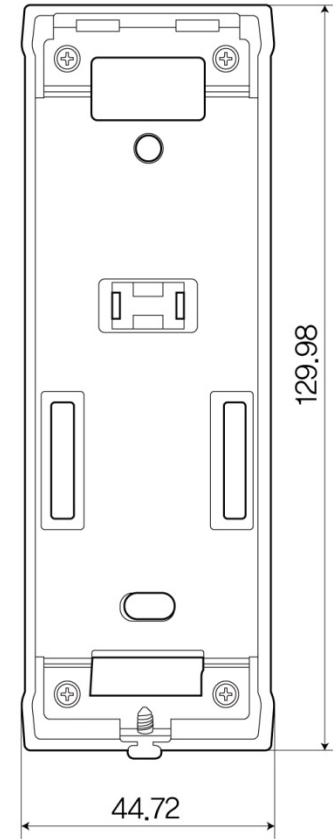

< Extended Bracket >

## Cables and Connectors

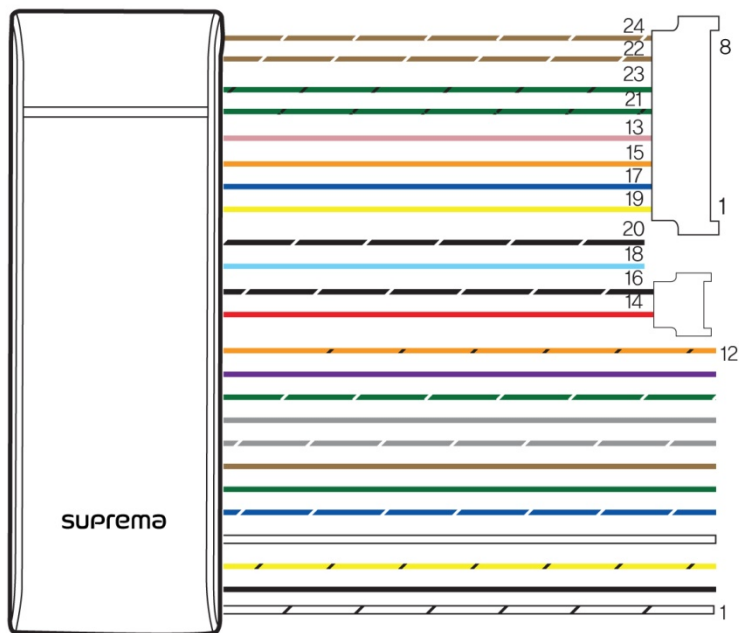

A Cross Section of Cable



No	Pin Name	Full Name	Color
1	485 GND	485 GND	White (black string)
2	WG GND	Wiegand-GND	Black
3	485 TRXN	485 -	Yellow (black string)
4	WG D1	Wiegand-1	White
5	485 TRXP	485 +	Blue (white string)
6	WG D0	Wiegand-0	Green
7	TTL IN1	Input-1	Brown
8	RLY NO	Relay Open	Gray (white string)
9	TTL GND	Input-GND	Gray
10	RLY COM	Relay Com	Green (white string)
11	TTL IN0	Input-0	Purple
12	RLY NC	Relay Close	Orange (black string)
13	ENET TXP	TX+ (LAN)	Pink
14	PWR +VDC	Power IN+	Red
15	ENET TXN	TX- (LAN)	Orange
16	PWR GND	Power IN-	Black (white string)
17	ENET RXP	RX+ (LAN)	Blue
18	PWR OUT	Power OUT+	Light Blue
19	ENET RXN	RX- (LAN)	Yellow
20	PWR GND	Power OUT-	Black (white string)
21	VB1	VB1	Green (black string)
22	VB2	VB2	Brown (white string)
23	VB1	VB1	Green (black string)
24	VB2	VB2	Brown (white string)

## Cables and Connectors

### Cable Specification

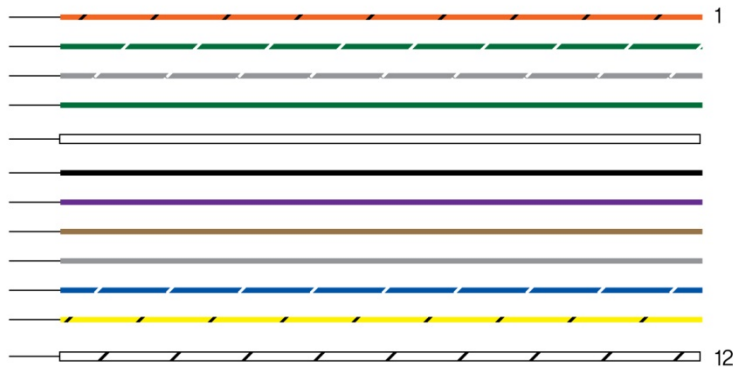

Cable	Pin Name	Color	
Relay	1	RLY NC	Orange (black string)
	2	RLY COM	Green (white string)
	3	RLY NO	Gray (white string)
Wiegand	4	WG D0	Green
	5	WG D1	White
	6	WG GND	Black
Switch	7	TTL IN0	Purple
	8	TTL IN1	Brown
	9	TTL GND	Gray
485	10	485 TRXP	Blue (white string)
	11	485 TRXN	Yellow (black string)
	12	485 GND	White (black string)

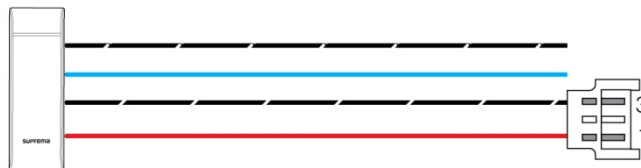

Adaptor Connector	Pin Name	Color	
Power		PWR GND	Black (white string)
		PWR OUT	Light Blue
	3	PWR GND	Black (white string)
	1	PWR +VDC	Red

### LAN cable

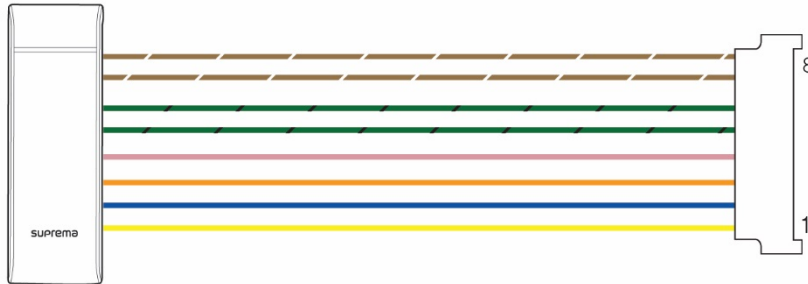

LAN Connector	Pin Name	Color
1	ENET RXN	Yellow
2	ENET RXP	Blue
3	ENET TXN	Orange
4	ENET TXP	Pink
5	VB1	Green (black string)
6	VB1	Green (black string)
7	VB2	Brown (white string)
8	VB2	Brown (white string)

### Ethernet extension cable

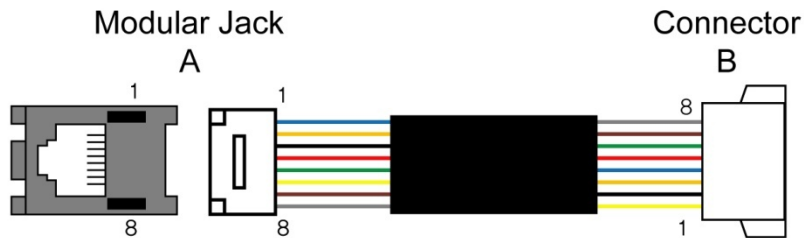

Modular Jack (A)	Connector (B)	Pin Name	Color
1	4	ENET TXP	Blue
2	3	ENET TXN	Orange
3	2	ENET RXP	Black
6	1	ENET RXN	Yellow
4	5	VB1	Red
5	6	VB1	Green
7	7	VB2	Brown
8	8	VB2	Gray

## Power Connection 1

Pin	Pin Name	Color
14	PWR +VDC	Red
16	PWR GND	Black (white string)

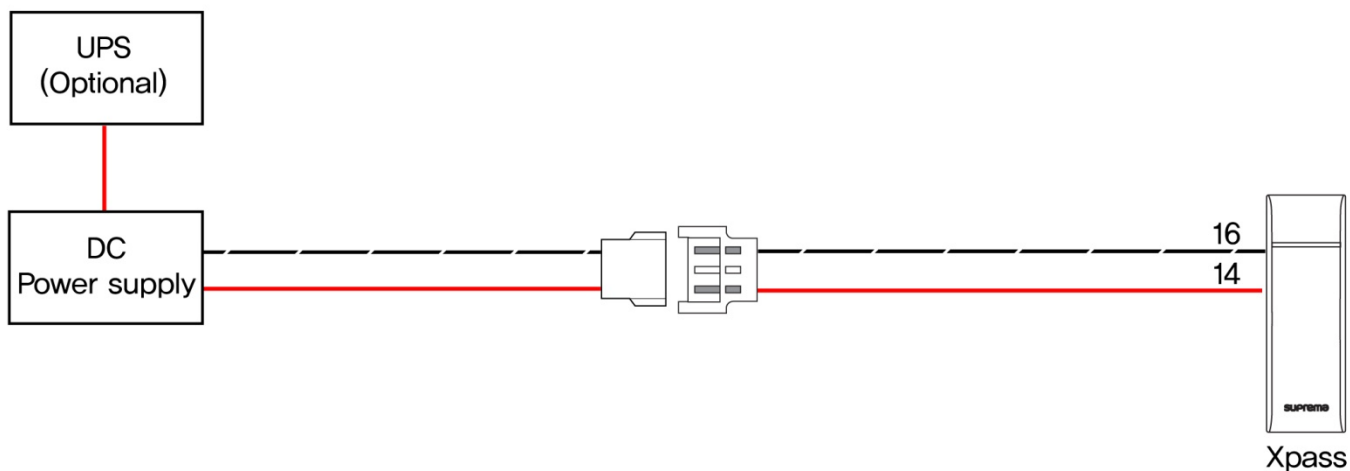

### Recommended power supply

- 12V  $\pm$  10%, at least 1500mA.
- Comply with standard IEC/EN 60950-1.
- Use a separate power supply for Secure I/O, electric lock and Xpass respectively. If connecting and using the power supply to these devices together, the devices may malfunction.

## Power Connection 2

Please read below carefully before you install this product. This is essential steps for stable operation. **Please make sure to turn on the power of PSE only after connect all cables related to PoE**

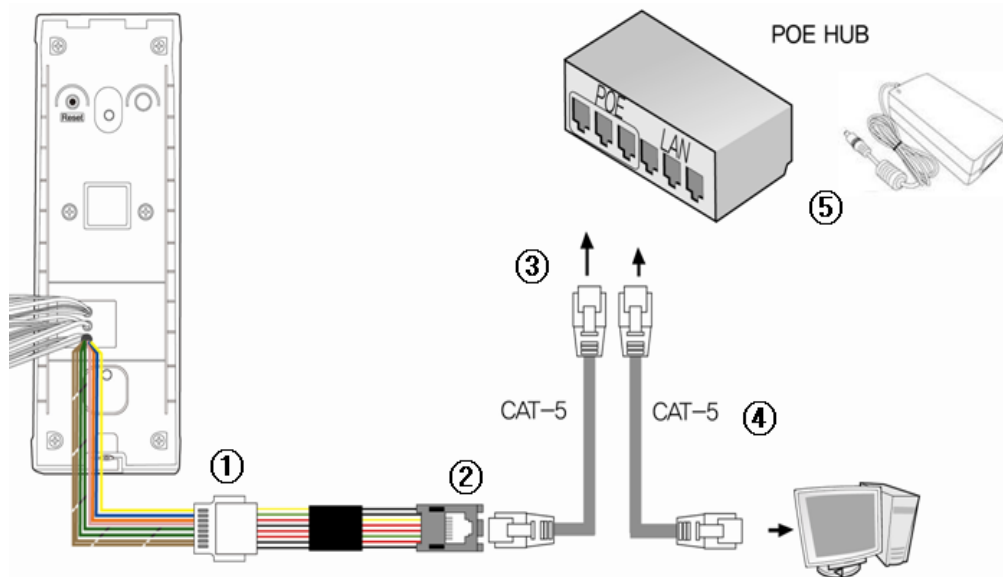

① Connect 8port Ethernet connect of Xpass body to Ethernet expansion cable in right direction

② Connect RJ45 modular from Ethernet expansion cable to Ethernet cable with CAT-5

③ Connect the opposite side of Ethernet cable to PoE HUB port

④ Connect cable from PC to port from PoE HUB and connect the opposite side of cable to Ethernet port of PC

⑤ Connect power of PoE HUB

## Recommended Power Supply

Please use the distance of LAN cable within 100m in case of PoE power.

PoE(Power over Ethernet)

: Use PSE(Power sourcing Equipment) that complies with IEEE802.3af standard only.

## LAN Connection

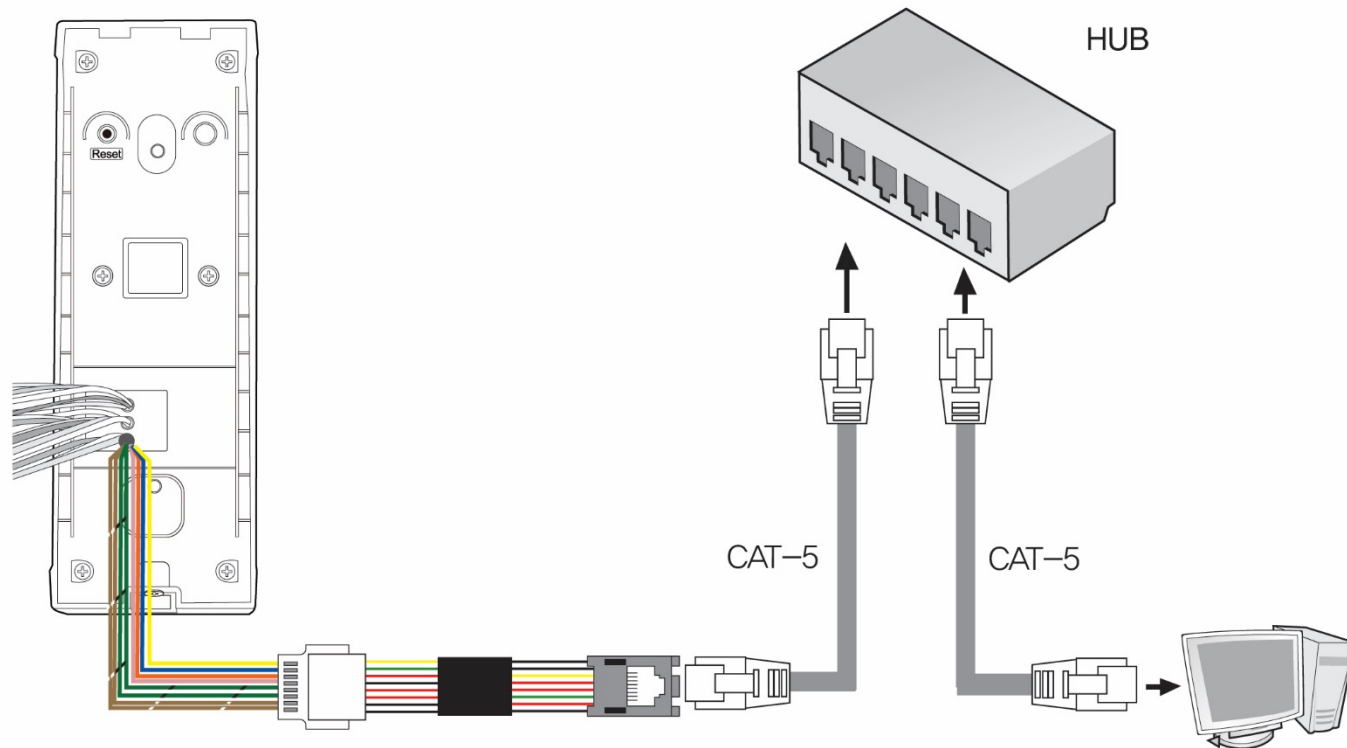



## LAN Connection (Direct connection with PC)

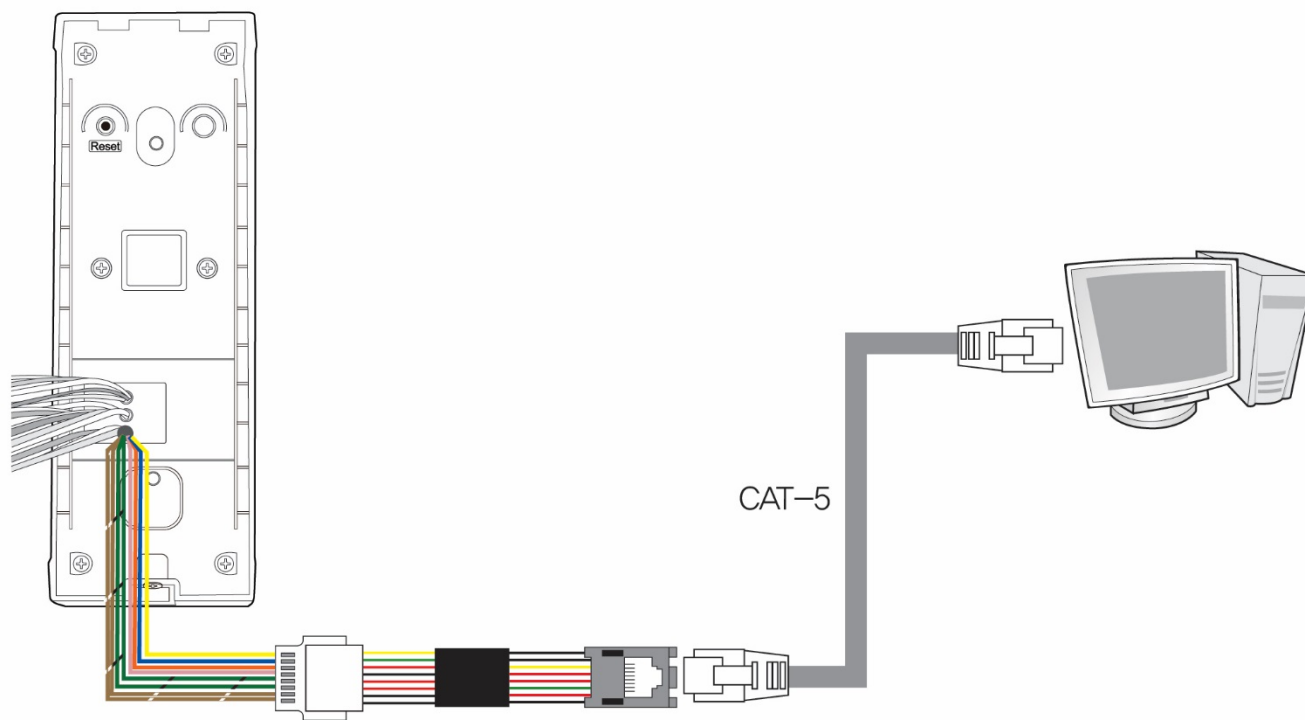

## RS485 Connection for Host Communication

Pin	Pin Name	Color
1	485 GND	White (black string)
3	485 TRXN	Yellow (black string)
5	485 TRXP	Blue (white string)

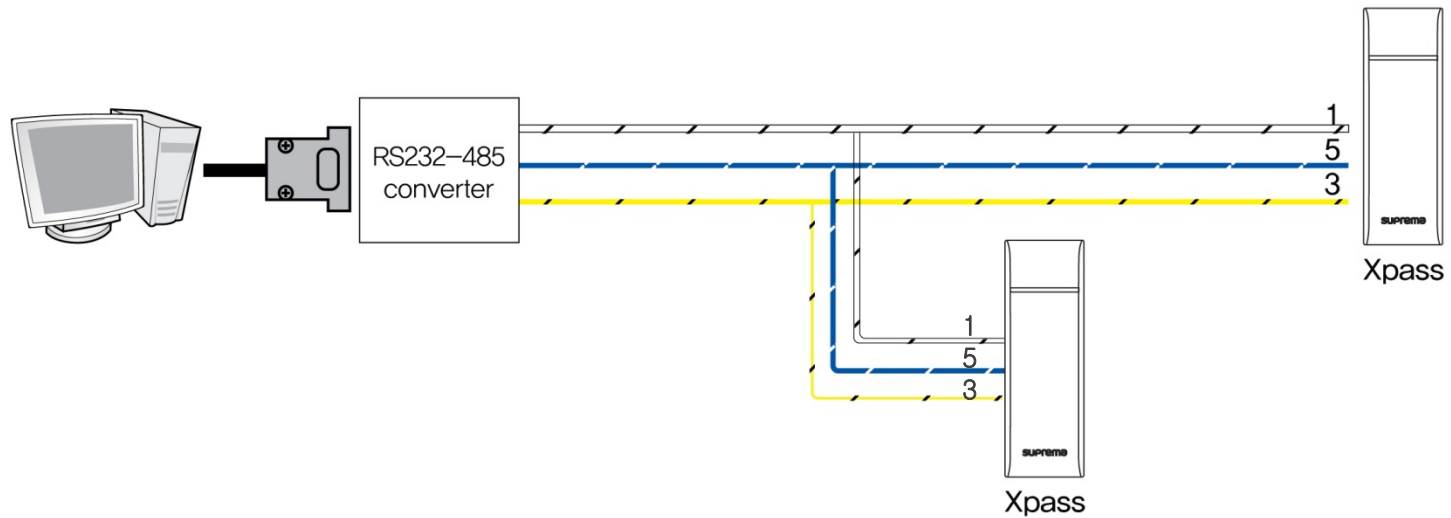

## RS485 Connection for Secure I/O

Pin	Pin Name	Color
1	485 GND	White (black string)
3	485 TRXN	Yellow (black string)
5	485 TRXP	Blue (white string)

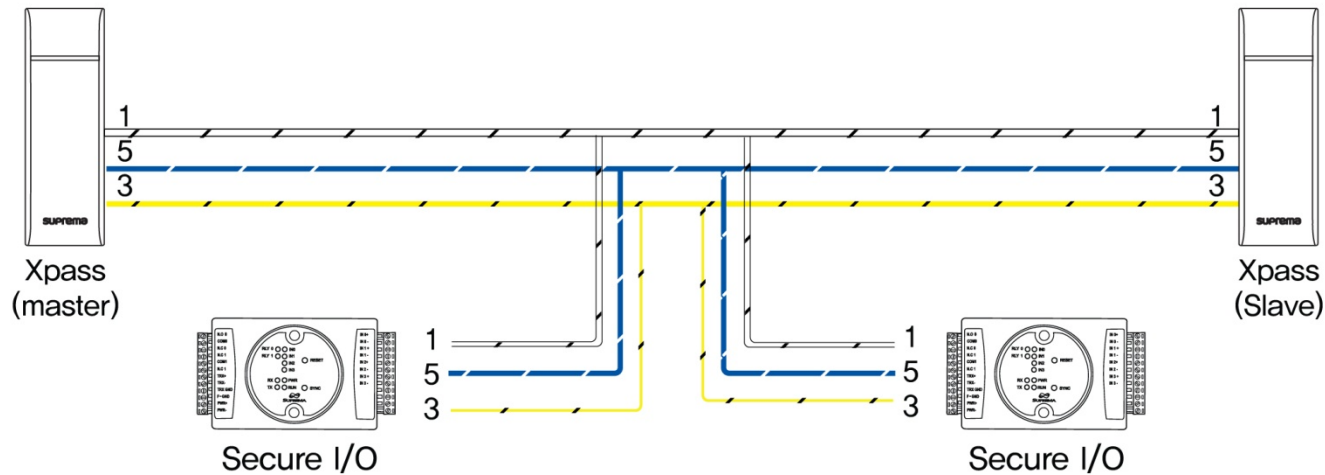

### Max number of devices

Maximum eight(8) devices (including Master) interworks in an RS485 loop.

## Relay Connection – Fail safe lock

Pin	Pin Name	Color
10	RLY COM	Green (white string)
12	RLY NC	Orange (black string)

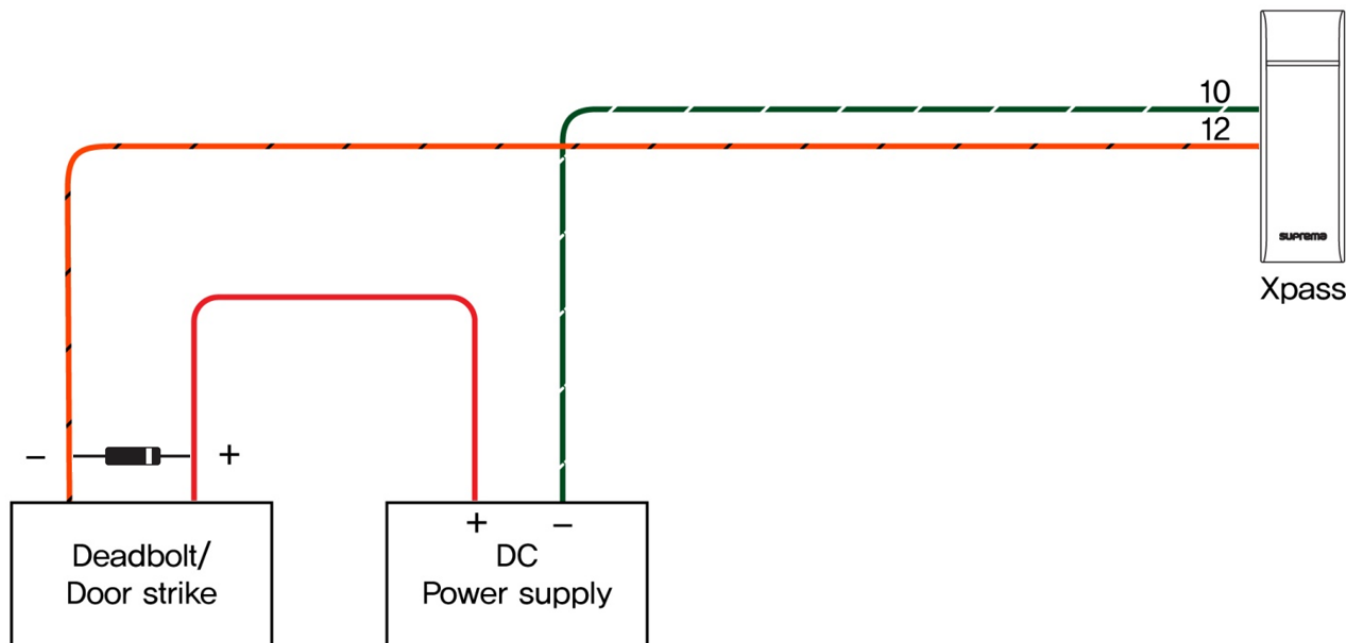

- Take care of the direction of the diode.
- Make sure to install the diode near to the door lock.
- Make sure to use different power supplies for the Xpass and the door lock.
- Make sure to install the diode at both ends of the circuit as shown in the figure above in order to protect the relay contact from the reverse current that occurs when the door lock works.

## Relay Connection – Fail secure lock

Pin	Pin Name	Color
8	RLY NO	Gray (white string)
10	RLY COM	Green (white string)

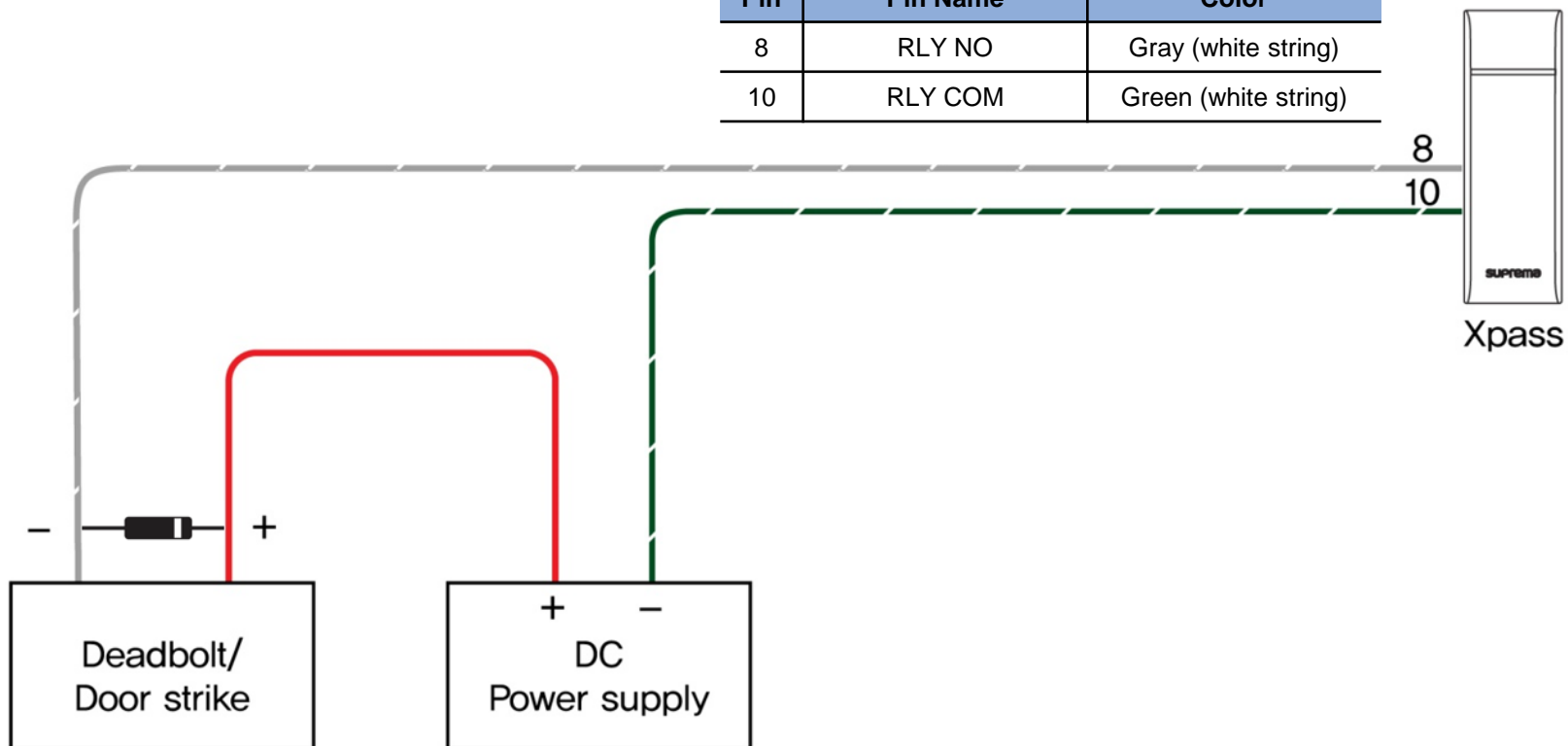

- Take care of the direction of the diode.
- Make sure to install the diode near to the door lock.
- Make sure to use different power supplies for the Xpass and the door lock.
- Make sure to install the diode at both ends of the circuit as shown in the figure above in order to protect the relay contact from the reverse current that occurs when the door lock works.

## Relay Connection - Automatic door

Pin	Pin Name	Color
8	RLY NO	Gray (white string)
10	RLY COM	Green (white string)

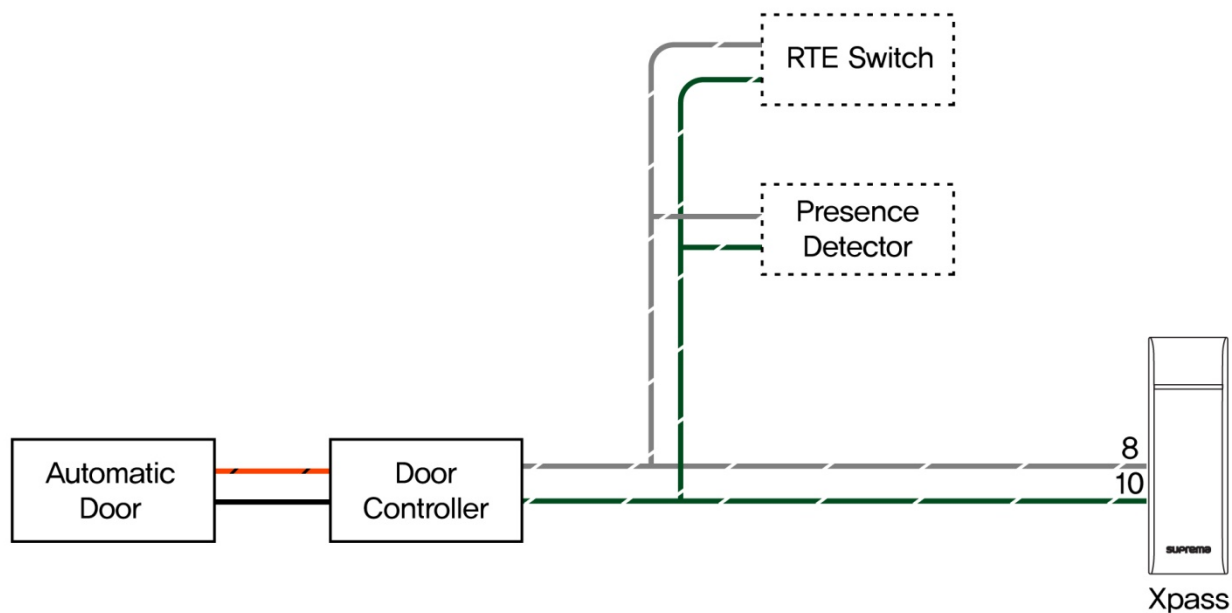

## Digital Input Connection (Alarm, Emergency S/W)

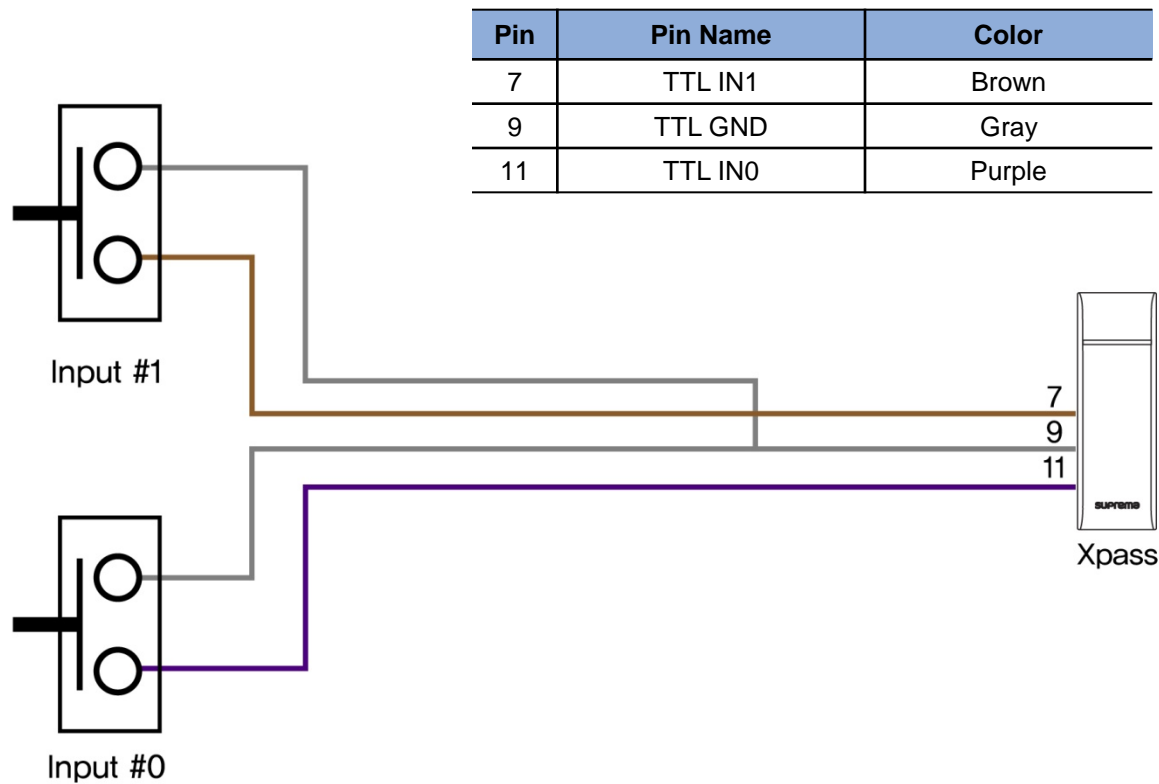

## Digital Input Connection (RTE, Door sensor)

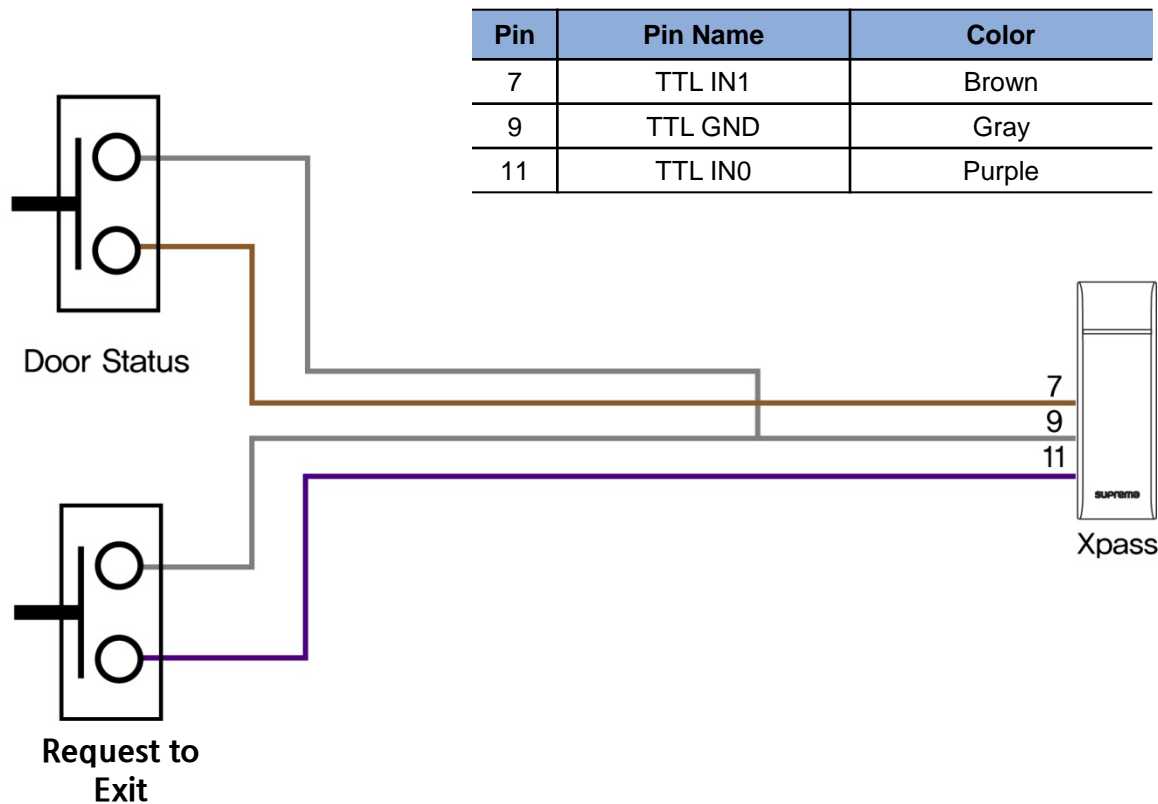



## Wiegand Input/Output

### Wiegand Input

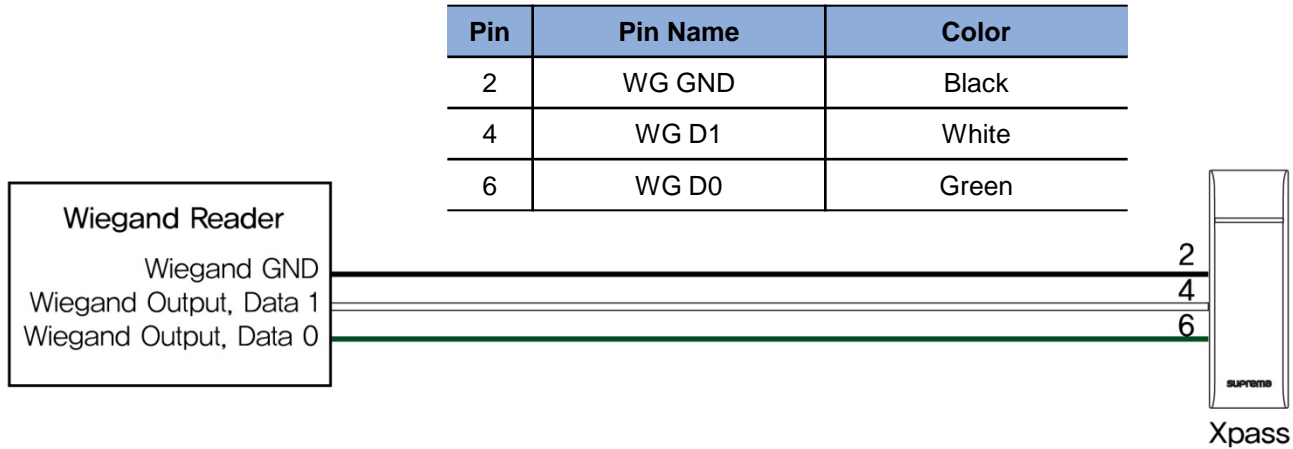

### Wiegand Output

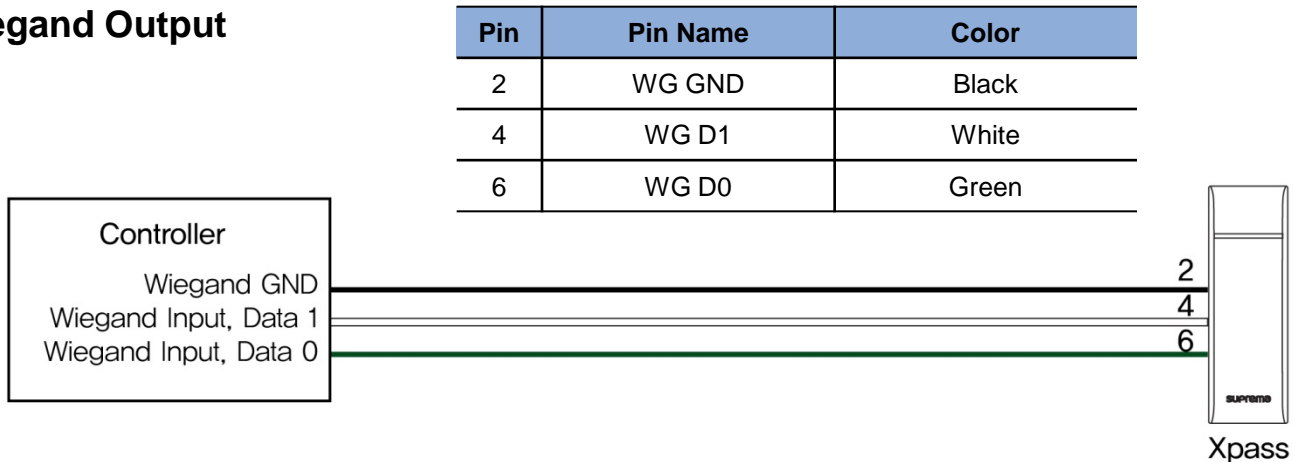

## External Power Output

- The external output provides a maximum current of 620 mA.
- Xpass connected to PoE supports the external power output.
- Be careful not to disconnect the power supply to Xpass when the external power output is connected to a door lock. Disconnecting the power supply to Xpass may cause security problems.
- The maximum switching current of the door lock should not exceed 620 mA. For more information on the maximum switching current of the door lock, contact the manufacturer.

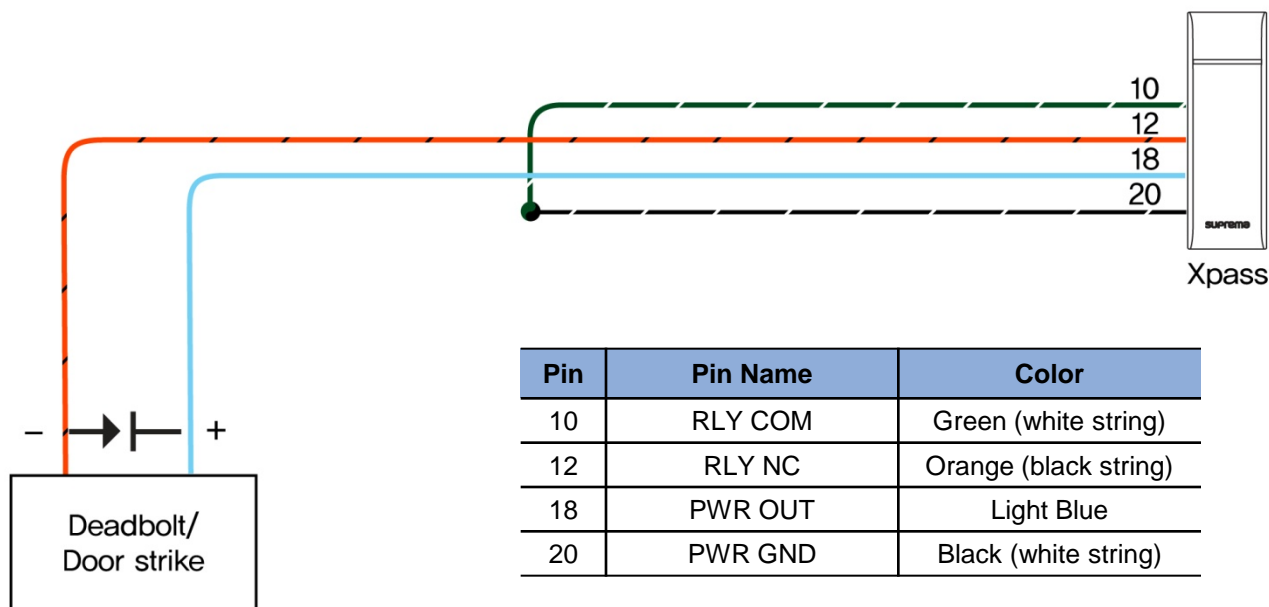

## Installation of Wall-mount Bracket

- Fix wall mount bracket on a wall using wall mounting screws

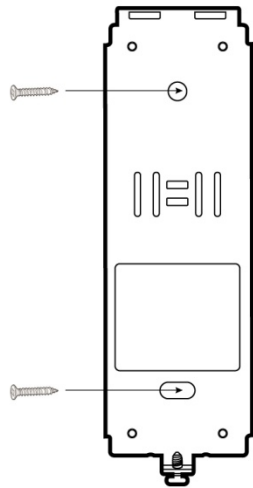

- Hook Xpass on the wall mount bracket

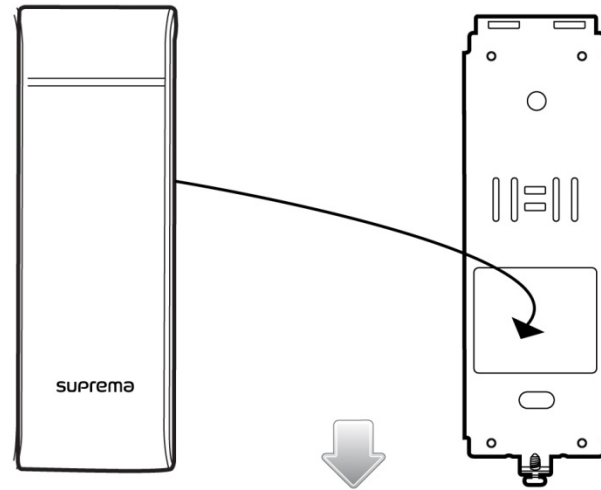

- Fix Xpass and wall mounting bracket using a wall mounting screw.

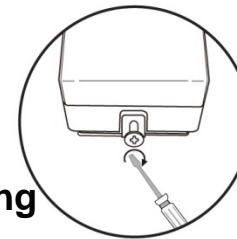

## Installation Reference 1 - Stand alone

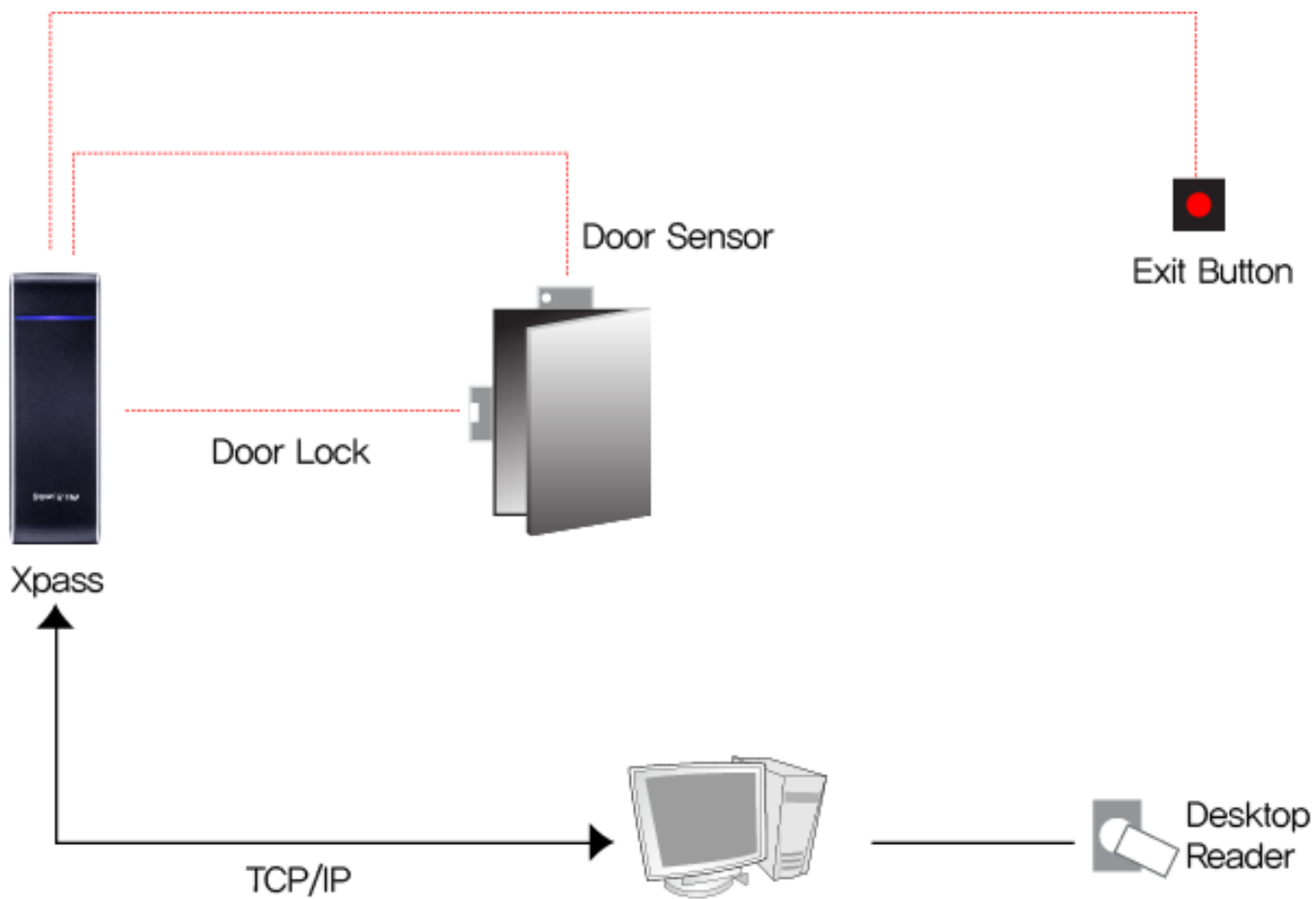

## Installation Reference 2 – Standalone (Secure)

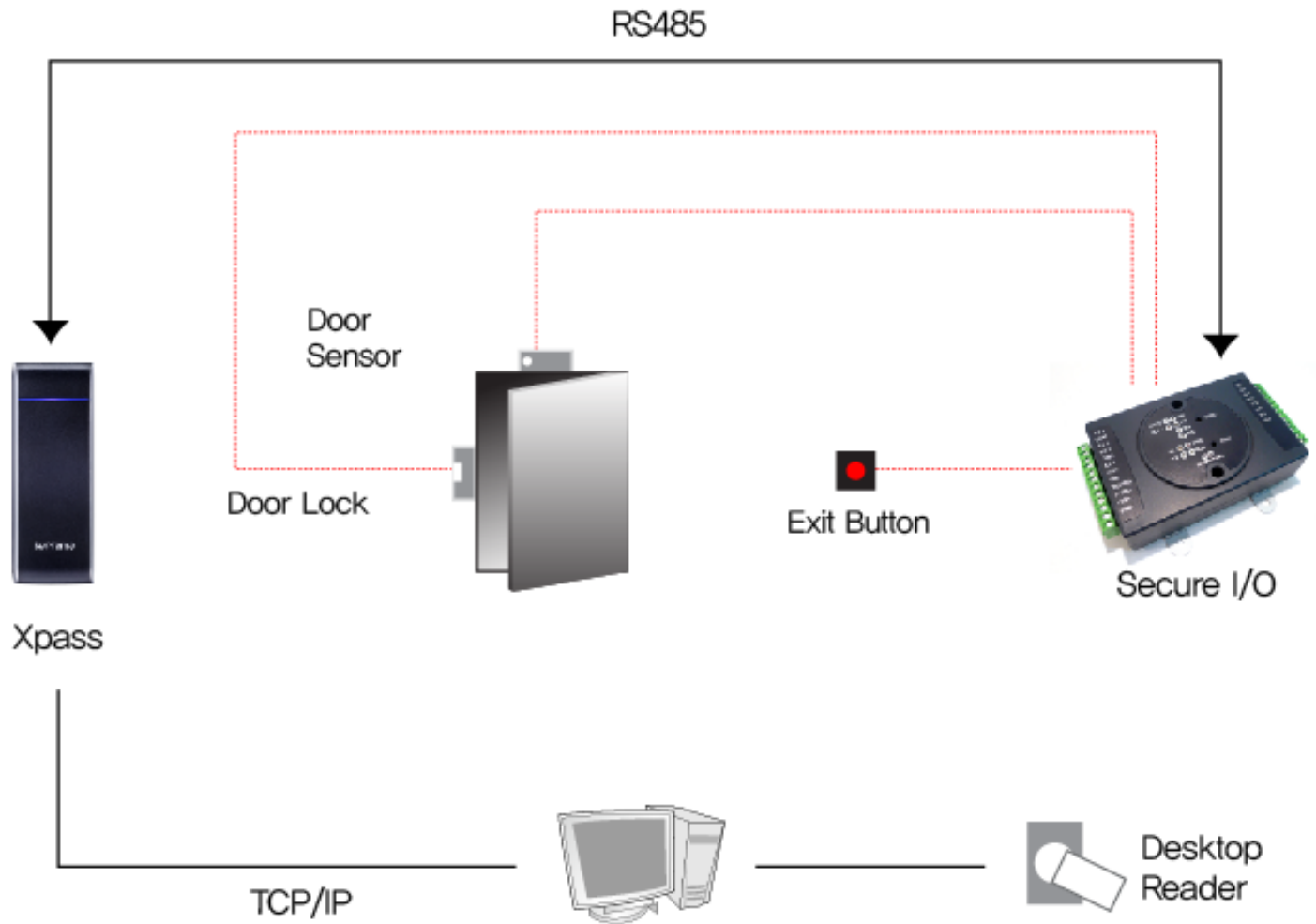

# Installation Reference 3 – Network

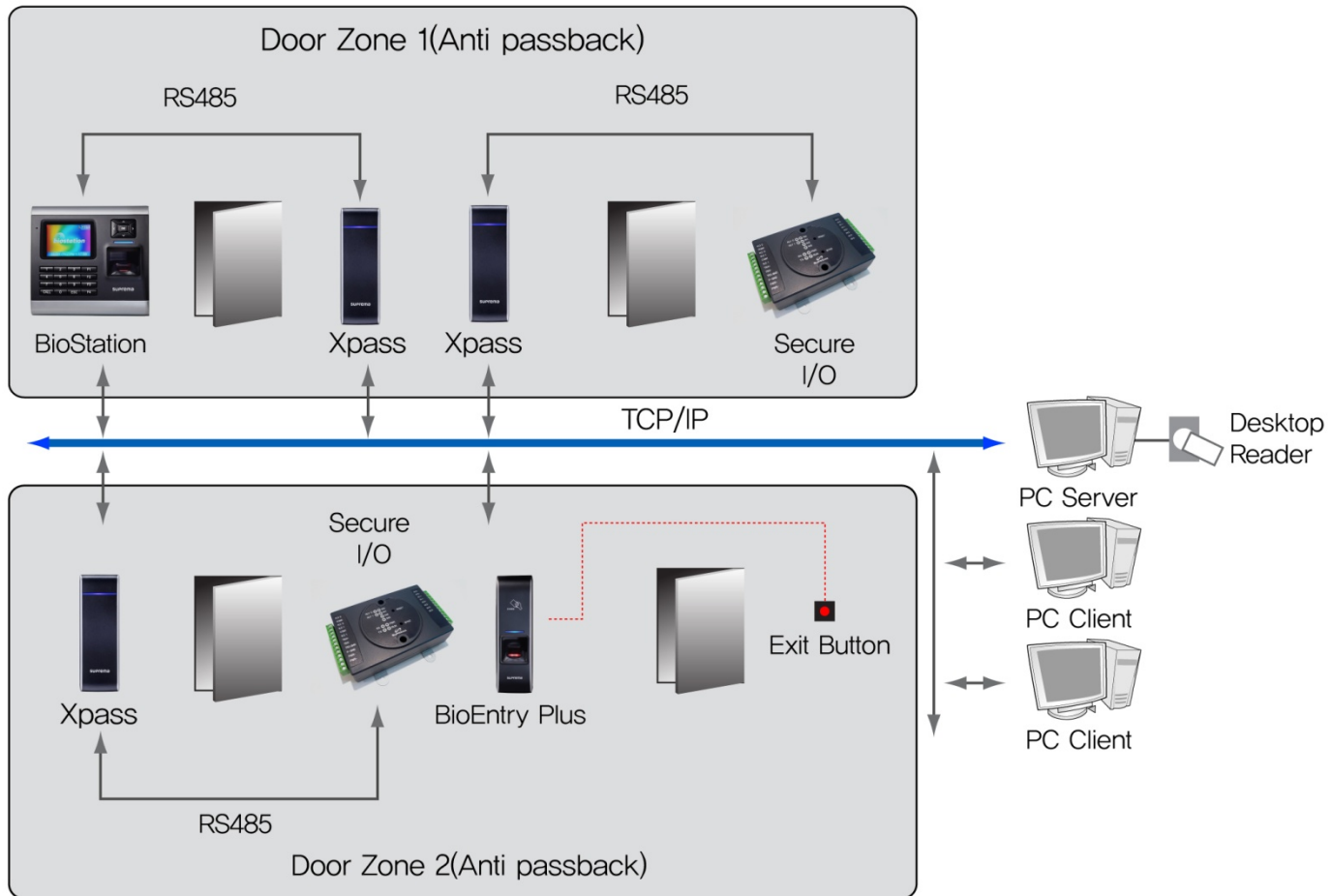

## Specification

<b>CPU</b>	32 bit Micro-processor
<b>Memory</b>	8MB FLASH + 16MB SDRAM
<b>RF Card</b>	13.56 MHz Mifare (XPM) 125 KHz EM Prox (XPE) 125 KHz HID Prox (XPH)
<b>User Capacity</b>	40000 user
<b>Log Capacity</b>	50000 log
<b>Network interfaces</b>	TCP/IP, RS485
<b>IP Rate</b>	IP 65 class
<b>Sound</b>	Multi-tone buzzer
<b>LED</b>	Multi-color LED
<b>RTC</b>	Lithium-ion rechargeable batteries
<b>I/O</b>	Relay x 1 Tamper x 1 Switch input x 2 Wiegand x 1
<b>Power</b>	12Vdc, POE
<b>Operating Temperature</b>	-20 ~ 50°C
<b>Size</b>	45 x 130 x 27mm (W x H x D )
<b>Certificates</b>	CE, FCC, KC, IP65



### Caution for RTC Battery

It may be occurred the risk of explosion for improper replacement of battery.  
Please use the specified battery according to proper instruction.

## Electrical Specification

	Min.	Typ.	Max.	Notes
<b>Power</b>				
Voltage (V)	10.8	12	13.2	Use regulated DC power adaptor only
Current Consumption (mA)	-		220	
<b>Switch Input</b>				
VIH (V)	2.0	-	10.0	
VIL (V)	-	-	0.4	
Pull-up resistance ( $\Omega$ )	-	4.7k	-	The input ports are pulled up with 4.7k resistors
<b>TTL/Wiegand Output</b>				
VOH (V)	-	5	-	
VOL (V)	-	0.8	-	
Pull-up resistance ( $\Omega$ )	-	4.7k	-	The outputs ports are open drain type, pulled up with 4.7k resistors internally
<b>Relay</b>				
Voltage	-	-	24 VDC	
Current	-	0.5 A	1.0 A	



## FCC Rules

### Caution

Changes or modifications not expressly approved by the manufacturer responsible for compliance could void the user's authority to operate the equipment.

### Warning

This device complies with part 15 of the FCC Rules. Operation is subject to the following two conditions: (1) This device may not cause harmful interface, and (2) this device must accept any interface received, including interference that may cause undesired operation.

### Information to User

This equipment has been tested and found to comply with the limit of a Class B digital device, pursuant to Part 15 of the FCC Rules. These limits are designed to provide reasonable protection against harmful interference in a residential installation. This equipment generates, user and can radiate radio frequency energy and, if not installed and used in accordance with the instructions, may cause harmful interference to radio communications.

However, there is no guarantee that interference will not occur in a particular installation; if this equipment does cause harmful interference to radio or television reception, which can be determined by turning the equipment off and on, the user is encouraged to try to correct the interference by one or more the following measures:

1. Reorient / Relocate the receiving antenna.
2. Increase the separation between the equipment and receiver.
3. Connect the equipment into an outlet on a circuit difference from that to which the receiver is connected.
4. Consult the dealer or an experienced radio/TV technician for help



Suprema Inc.  
16F Parkview Office Tower, Jeongja-dong, Bundang-gu,  
Seongnam, Gyeonggi, 463-863 Korea  
E-mail : [support@supremainc.com](mailto:support@supremainc.com)  
Website : [www.supremainc.com](http://www.supremainc.com)

Functions and specifications of the product are subject to changes without notice due to quality enhancement or function update. For any inquiry on the product, please contact Suprema Inc.